

Rozměry v mm
 Maße in mm
 Dimensions in mm

853LF21
 261kg

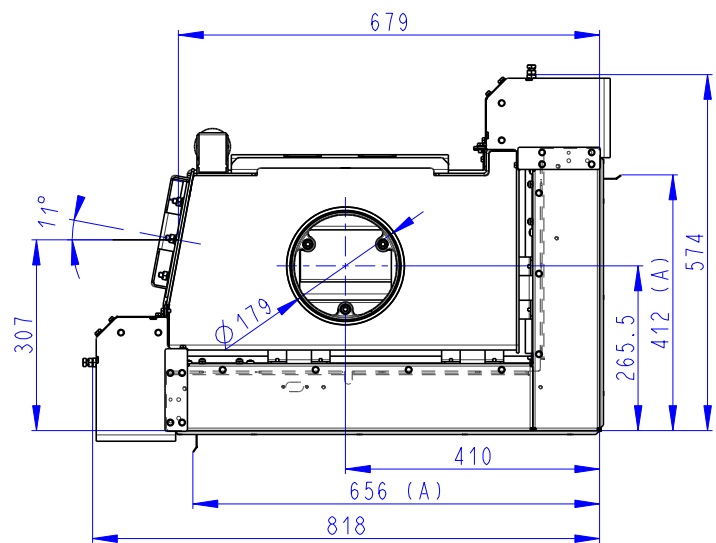
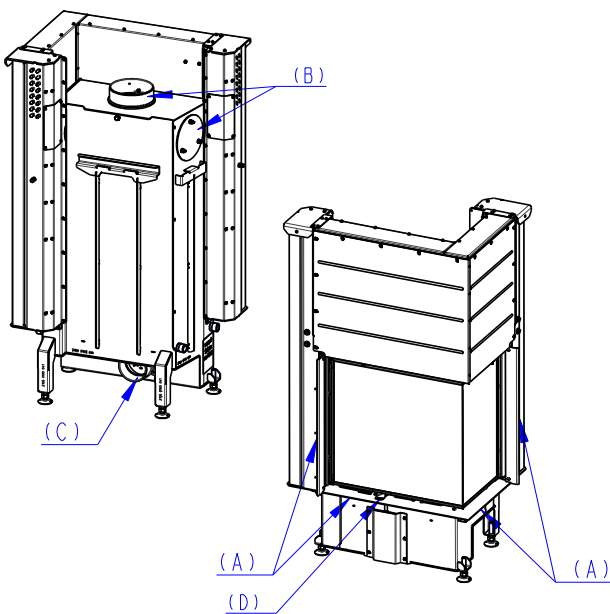
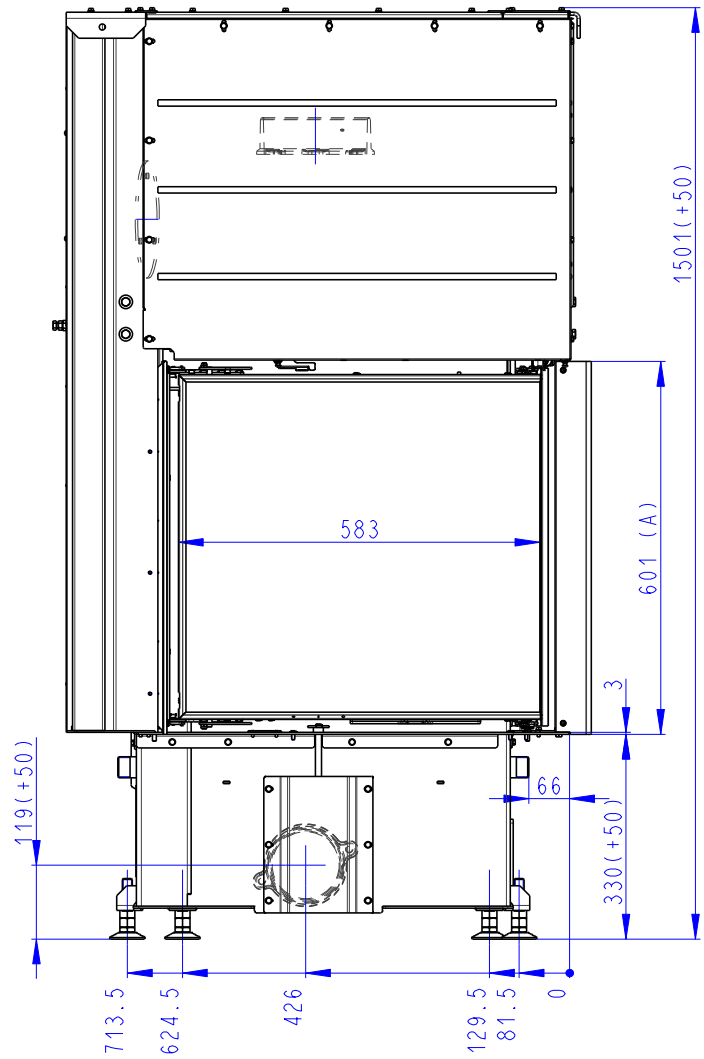
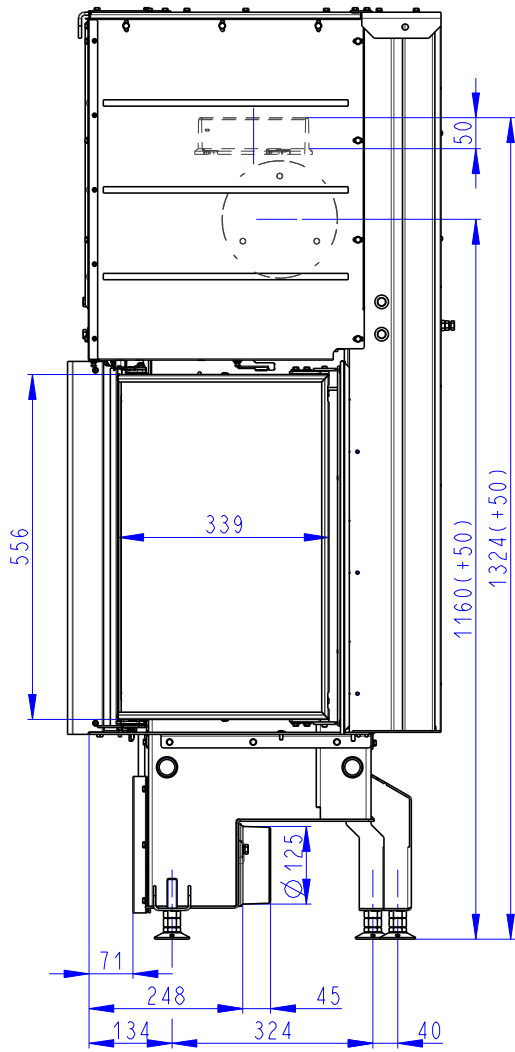

- (A) Zastavbovy rozmer / Baumaße / In-built dimension
 (B) Litinový odvod kouře / Cast iron spigot / Der gusseiserne Rauchabgang
 (C) Centralni privod vzduchu / Central air inlet / Zentralluftzufuhr
 (D) Primarni a sekundarni vzduch / Primary and secondary air / Primärluft und Sekundärluft